



Professional aluminum football goals 7,32x2,44 m

Made of special oval aluminum profile 120x100 mm with double reinforcing ribs. The main frame of the goal powder coated in white. Installed in assembly sleeves.

The set includes:

- the main frame;
- assembly sleeves with masking lids;
- sleeve-mounted net tensioning posts, equipped with protective pads;
- upward-folding bottom frame for fastening the bottom edge of the net.

Football goals are certified for compliance with the FIFA standards.

9-01 Depth of the net 2 m

9-01-1 Depth of the net 3 m



Innovative joint system

Innovative system of connecting profiles in the corner of the goal transfers the loads from the profile directly to the steel corner connector, without applying the load to the screws, what considerably increases the durability of the goal.

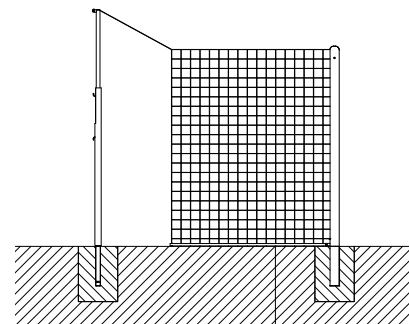

Bottom frame folding system for easy lawn care

Special assembly sleeves for football goals 7,32x2,44 m and lashings

Special assembly sleeves for full-size football goals 7,32x2,44 m and lashings, with integrated masking components. Available on request.

9-50



The sleeve ready for installation



Masking element, integrated with the sleeve



The sleeve after removal from the goal and masking



Special sleeve for lashings



Portable aluminum training football goals 7,32x2,44 m

Made of special oval aluminum profile 120x100 mm. The foldable bows enable fast assembly and disassembly as well as facilitate storage. Connection of the goal with the bottom frame ensures stability. Fixing to the ground using the pins driven into the soil.

9-02



The set of pins

The set of pins driven into the soil to install the goal consists of 8 pins (4 pins for one goal).



3-21

The load for goals

Protects the goal from falling over by pressing the lower frame to the ground. Weight after filling with sand: approx. 50 kg.



9-22-1

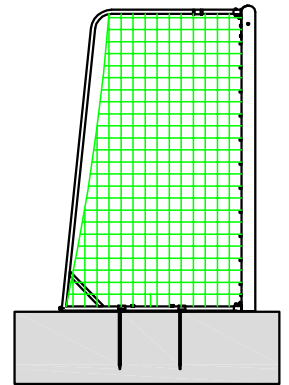

Mounting using fixing pins

Mobile aluminum football goals 7,32x2,44 m with 4 wheels

Mobile aluminum football goals 7,32x2,44 m with solid bows. The main frame of the goal, made of oval aluminum profile 120x100 mm with double strengthening ribs, consists of two vertical posts and a horizontal crossbar. These elements are joined by a connecting corner, fixed inside the aluminum profiles and screwed with conical head screws M8x20 from the outside. Bottom frame made of strengthened aluminum profile 80x80 mm, intended to be filled with sand. 4 wheels, fastened to the bottom frame, when unfolded, allow fast and easy transport of the goal. The frame of the goal is protected by anodizing or powder coating, steel elements are hot dip galvanized.

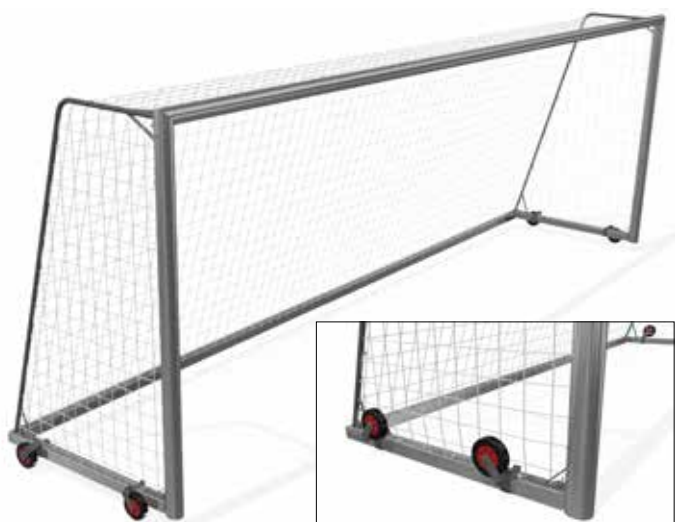

9-62



Football goals 5x2 m, oval aluminum profile

Football goals for youth 5x2 m are made of special oval aluminum profile 120x100 mm with double reinforcing ribs. Installed using installation plates / supports, fixing pins or in assembly sleeves embedded in the ground.

The structure of goals allows to fold them along with the net. All metal elements of the goal (apart from the main frame) are made of hot dip galvanized steel.



Goal mounted using installation plates / supports

9-06-1

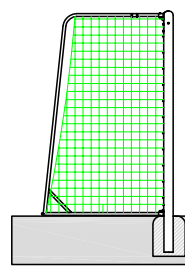

Goal mounted in assembly sleeves

9-05

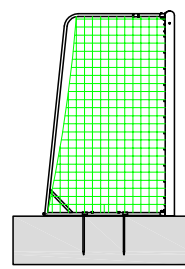

Goals mounted using fixing pins

9-06



Assembly systems:

Set of plates - support

Set of plates - support, embedded in concrete, to install the goals on asphalt or concrete socle. The set consists of 8 binding screws and 8 fixing plates.

3-22



Set of installation plates

The set of plates to install the goal on the sports floor consists of 8 binding screws and 8 fixing metal sheets. One set of plates for one pair of goals.

3-23



Assembly sleeve

Assembly sleeve with masking lid for installation of oval post.

9-05-51



Set of fixing pins

The set of pins driven into the soil to install the goal consists of 8 pins (4 pins for one goal).

3-21





Football goals 5x2 m, square profile

Made of square profile 80x80 mm – aluminum (available in two types: standard or reinforced) or steel, marked with black tape. The goals are assembled using installation plates / supports, fixing pins or assembly sleeves, concreted in the ground.

The structure of goals allows to fold them along with the net.

- 9-03** Football goals 5x2 m – aluminum profile
- 9-03D** Football goals 5x2 m – reinforced aluminum profile
- 9-04** Football goals 5x2 m – steel profile

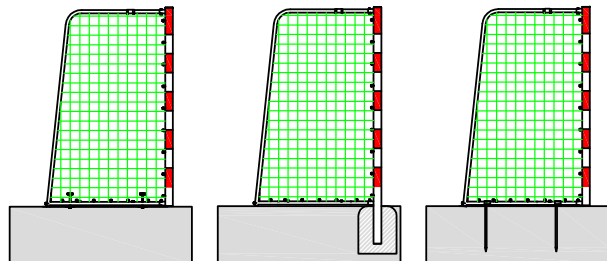

Goal mounted using installation plates / supports (art. No. 3-23 and 3-22) Goal mounted in assembly sleeves (art. No. 3-20) Goal mounted using fixing pins (art. No. 3-21)

Assembly sleeve with adapter

Assembly sleeves with adapter, designed for installation goals, made of steel or aluminum profile 80x80 mm, on the outdoor fields or inside the sports halls. Hot dip galvanized.



3-20

85x100 mm

Football goals 5x2 m, square profile, extended, mounted in the sleeves, with folding bows

Made of square reinforced aluminum profile 80x80 mm, marked with black tape. Extended posts of the main frame are mounted directly into the sleeves, so adapters are not needed.

- 9-03DM** Football goals 5x2 m, reinforced aluminum profile 80x80, extended; the main frame of the goal connected at the corners using special steel element (demo-ntable).



80x80 mm



Assembly sleeve for post 80x80 mm

The sleeve made of steel profile 90x90 mm, protected against corrosion by hot dip galvanizing.



2-04-1

90x90 mm

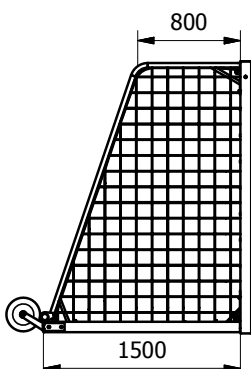

Portable aluminum football goals 5x2 m with wheels, main frame made of oval profile 120x100 mm

The main frame made of special reinforced oval aluminum profile 120x100 mm. Bottom frame made of reinforced aluminum profile 80x80 mm. The bows made of steel pipes (galvanized) with the diameter of 35 mm. The net with the mesh 120x120 mm and the weave 3 - 5 mm thick is fixed, using special plastic clips. The ability to disassemble the goal facilitates transport and storage. The bottom frame must be filled with sand. In addition, the goal can be equipped with a load, made of the rod with the diameter of 50 mm (the set does not contain additional load).

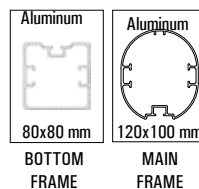

9-61

Portable aluminum football goals 5x2 m with wheels, square profile 80x80 mm

The main frame and bottom frame made of special aluminum profile 80x80 mm with additional ribs to strengthen structure of the goal. The bows made of steel pipes (galvanized) with the diameter of 35 mm. The net with the mesh 120x120 mm and the weave 3 - 5 mm thick is fixed, using special plastic clips. The ability to disassemble the goal facilitates transport and storage. The bottom frame must be filled with sand. In addition, the goal can be equipped with a load, made of the rod with the diameter of 50 mm (the set does not contain additional load).



9-60

The load for goals made of the rod

The load for goals, made of the rod 50 mm thick and protecting metal sheets. Mounted to stabilize the goal. Weight of 1 piece: 85 kg.



9-63

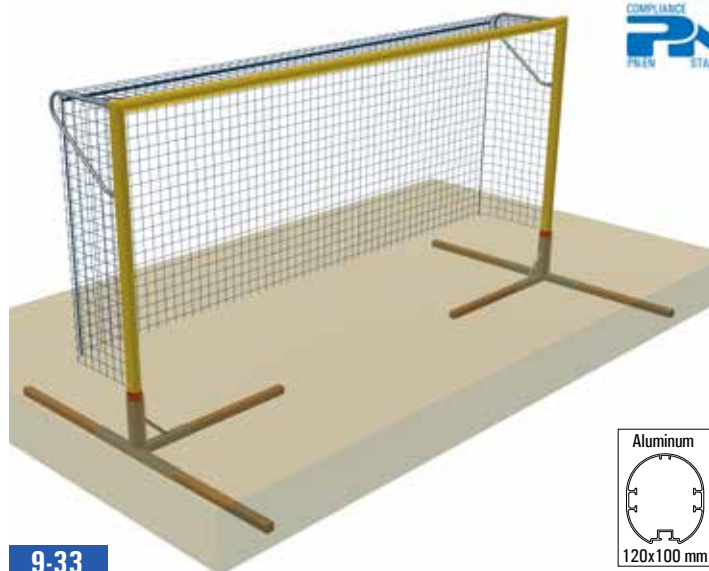

Assembly sleeve for beach football goal, embedded in the sand

Designed for mounting beach football goals with oval aluminum posts (profile 120x100 mm), made of steel.



9-33

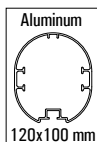

Beach football goals

Beach football goals 5,50x2,20 m are made of special oval aluminum profile 120x100 mm, with double reinforcing ribs. Depth of the goal: 80 cm. The surface of the profile is powder coated in yellow. The goals are installed in the special sleeves, with special square-sawn timbers, embedded in the sand. Demountable bows allow convenient storage. All metal elements, apart from the main frame, are made of steel and hot dip galvanized (foldable bows, lower crossbar). The main frame is connected in the corners, using safe and easy to use plastic handles. Assembly elements for mounting under other conditions also available.

Football nets

We offer a complete selection of nets for football goals (full size 7,32x2,44 m, goals for youth 5x2 m and beach football goals). Among the models are professional, training and tournament nets for stationary and portable football goals.

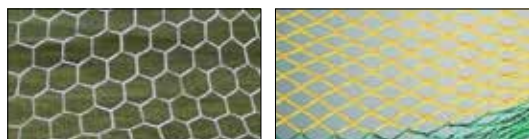

Beach football field boundary lines



Beach football field boundary lines Pesm-H, colour: blue. Fastened with wooden planks buried in the sand. Made of polypropylene tape.

9-33-15



Beach football field boundary lines (field 27,5x36,5 m), colour: blue.

9-20-3



Art. No.	Portable Mini-Football goals
9-53-1	Mini-football goals 0,8x1,2 m. Made of aluminum profile 80x80 mm, with demountable bows, depth 50 cm (top and bottom), two fixing points. The nets are included in the set.
9-51-1	Mini-football goals 1,0x1,5 m. Made of aluminum profile 80x80 mm, with demountable bows, depth 50 cm (top and bottom), two fixing points. The nets are included in the set.
9-54	Mini-football goals 1,2x1,8 m. Made of aluminum profile 80x80 mm, with folding bows, depth 50 cm (top and bottom), two fixing points. The nets are included in the set.
9-52	Mini-football goals 1,6x2,4 m. Made of aluminum profile 80x80 mm, with folding bows, depth 50 cm (top and bottom), two fixing points. The nets are included in the set.
9-55	Mini-football goals 1,55x3 m. Made of aluminum profile 80x80 mm, with folding bows, depth 80 / 100 cm (top / bottom), two fixing points. The nets are included in the set.



Shelters for substitutes with acrylic glass cover

The supporting structure made of powder coated steel profiles, bottom frame protected against corrosion by hot dip galvanizing. Aluminum finishing of elements, cover made of acrylic glass 3 mm thick. Plastic seats with backrest. Optionally, the shelter can be equipped with a platform, finished with corrugated aluminum sheet and artificial grass. The shelter should be fixed to the ground. In order to facilitate the transport and handling of the shelter, it is possible to mount the wheels. Up to 14 seats in the shelter.

Art. No.	Number of seats	Length [m]
20-13-1	3-4	2
20-12-1	5-6	3
20-11-1	7-8	4
20-10-1	9-10	5
20-09-1	11-12	6
20-08-1	13-14	7



Shelter for substitutes PESMENPOL VIP

Double row shelter for substitutes, roofed, with upholstered armchairs type VIP. Galvanized supporting frame, powder coated structure. Aluminum finishing of elements, cover made of acrylic glass 6 mm thick, platform made of corrugated aluminum sheet, covered with artificial grass and finished with a decorative angle bar. The upper beam secured with protective material, covered with synthetic leather. Possibility of installing up to 16 seats in the shelter.

20-07



Shelter for substitutes with cellular polycarbonate cover

The supporting structure made of powder coated steel profiles, bottom frame protected against corrosion by hot dip galvanizing. Aluminum finishing of elements, cover made of cellular polycarbonate. Plastic seats with backrest. Optionally, the shelter can be equipped with a platform, finished with corrugated aluminum sheet and artificial grass. The shelter should be fixed to the ground. In order to facilitate the transport and handling of the shelter, it is possible to mount the wheels. Up to 14 seats in the shelter.

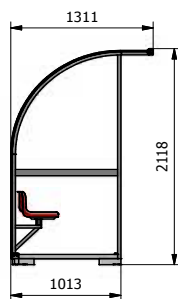

Art. No.	Number of seats	Length [m]
20-13-2	3-4	2
20-12-2	5-6	3
20-11-2	7-8	4
20-10-2	9-10	5
20-09-2	11-12	6
20-08-2	13-14	7

Telescopic tunnel for football stadium

Tunnel for football stadium with telescopic system of folding and unfolding. Hot dip galvanized steel structure, aluminum finishing. PVC cover 600 g/m², colour according to the palette of available materials. Plastic rubber coated or polyamide system wheels for the running rail.

The tunnel is equipped with a locking system to prevent uncontrolled closing during use and stiffening the entire structure after unfolding.

The tunnel cover is made of polyester fabric, coated with high-fire-resistant PVC.

9-2100 Telescopic tunnel for football stadium SPT-1. Width inside S=235 cm, internal height H1=230 cm, height H2=275 cm (at the top)

9-2101 Telescopic tunnel for football stadium SPT-2. Width inside S=190 cm, internal height H1=200 cm, height H2=230 cm (at the top)



The running rail for telescopic tunnel

The running rail for the rolls to fold and unfold the telescopic tunnel, made of hot dip galvanized steel, installed permanently or demountable.

9-2110



Steel handball goals, the main frame all-welded

The goals, made and marked in accordance with the IHF standard, are extremely durable and rigid; marked as a standard in red (marking in blue or black available on request). Made in following variants:

Steel
 **3-40** Professional steel handball goals 2x3 m, hot dip galvanized, made of profile 80x80 mm, with steel folding bows. The main frame all-welded.
 80x80 mm

The goals are available with the standard depth (bottom / top):
 A - 1200 mm / 1000 mm
 B - 1000 mm / 800 mm
 C - 800 mm / 600 mm
 D - 500 mm
 PX - wall brackets in length L = X [mm] (for wall-mounted goals)

Steel
 **3-40-1** Professional steel handball goals 2x3 m, hot dip galvanized, made of profile 80x80 mm, with steel solid bows. The main frame all-welded.
 80x80 mm

The goals are available with the standard depth (bottom / top):
 A - 1200 mm / 1000 mm
 B - 1000 mm / 800 mm
 PX - wall brackets in length L = X [mm] (for wall-mounted goals)

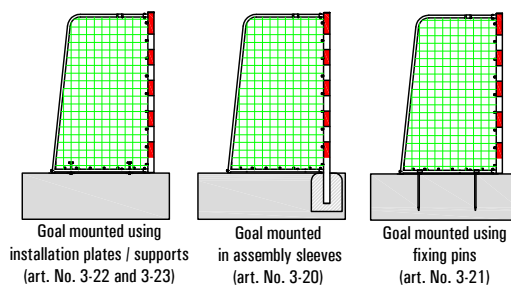
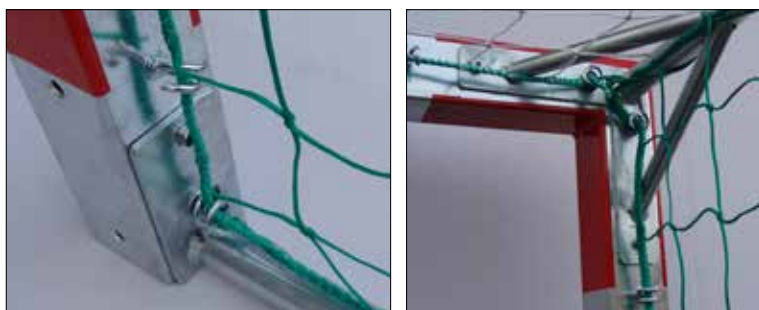

The net is fixed to the steel profile, using safe and durable steel grips.

The foldable bows, made of galvanized steel pipe Ø35, enable fast assembly and disassembly as well as facilitate storage.

Goals intended for indoor and outdoor use.

For open sport facilities we recommend fixing the goals using a sleeve with adapters.

Assembly sleeves with adapter

Assembly sleeves with adapter, designed for installation goals, made of steel or aluminum profile 80x80 mm, on the outdoor fields or inside the sports halls. Hot dip galvanized.



3-20

Steel profile

 85x100 mm



Aluminum handball goals, the main frame all-welded

The goals, made and marked in accordance with the IHF standard, are extremely durable and rigid; marked as a standard in red (marking in blue or black available on request). Made in following variants:

Aluminum



80x80 mm

3-41

Professional aluminum handball goals 2x3 m, reinforced, made of aluminum profile 80x80 mm, with folding bows. The main frame all-welded.

The goals are available with the standard depth (bottom / top):

A - 1200 mm / 1000 mm

B - 1000 mm / 800 mm

C - 800 mm / 600 mm

D - 500 mm

PX - wall brackets in length $L = X$ [mm] (for wall-mounted goals)

Aluminum



80x80 mm

3-41-1

Professional aluminum handball goals 2x3 m, reinforced, made of aluminum profile 80x80 mm, with steel solid bows. The main frame all-welded.

The goals are available with the standard depth (bottom / top):

A - 1200 mm / 1000 mm

B - 1000 mm / 800 mm

PX - wall brackets in length $L = X$ [mm] (for wall-mounted goals)

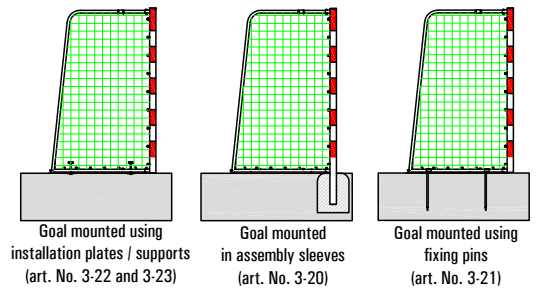

The net is fixed to the aluminum profile, using special clips, made of frost-resistant plastic, mounted in the groove of the profile.

The foldable bows, made of galvanized steel pipe $\varnothing 35$, enable fast assembly and disassembly as well as facilitate storage.

Goals intended for indoor and outdoor use.

For open sport facilities we recommend fixing the goal using a sleeve with adapters.





Aluminum handball goals, reinforced profile, the main frame connected in the corners

Aluminum



80x80 mm

3-42

Professional aluminum handball goals 2x3 m, made of reinforced aluminum profile 80x80 mm. Steel folding bows. The main frame of the goal connected in the corners using special steel joints, with the possibility of dismantling. The goals are assembled using installation plates / supports or fixing pins.

The goals are available with the standard depth (bottom / top):

A - 1200 mm / 1000 mm

B - 1000 mm / 800 mm

C - 800 mm / 600 mm

D - 500 mm

PX - wall brackets in length $L = X$ [mm] (for wall-mounted goals)

Aluminum



80x80 mm

3-42-1

Professional aluminum handball goals 2x3 m, made of reinforced aluminum profile 80x80 mm. Steel solid bows. The main frame of the goal connected in the corners using special steel joints, with the possibility of dismantling. The goals are assembled using installation plates / supports or fixing pins.

The goals are available with the standard depth (bottom / top):

A - 1200 mm / 1000 mm

B - 1000 mm / 800 mm

PX - wall brackets in length $L = X$ [mm] (for wall-mounted goals)



Aluminum handball goals, reinforced profile, the main frame connected in the corners, mounted in the sleeves

Extended posts of the main frame are mounted directly into the sleeves, so adapters are not needed.



Aluminum



80x80 mm

Professional aluminum handball goals 2x3 m, made of reinforced aluminum profile 80x80 mm, with folding bows. Mounted in assembly sleeves. The main frame of the goal connected in the corners using special steel joints, with the possibility of dismantling.

3-43

The goals are available with the standard depth (bottom / top):

A - 1200 mm / 1000 mm

B - 1000 mm / 800 mm

C - 800 mm / 600 mm

D - 500 mm

PX - wall brackets in length $L = X$ [mm] (for wall-mounted goals)

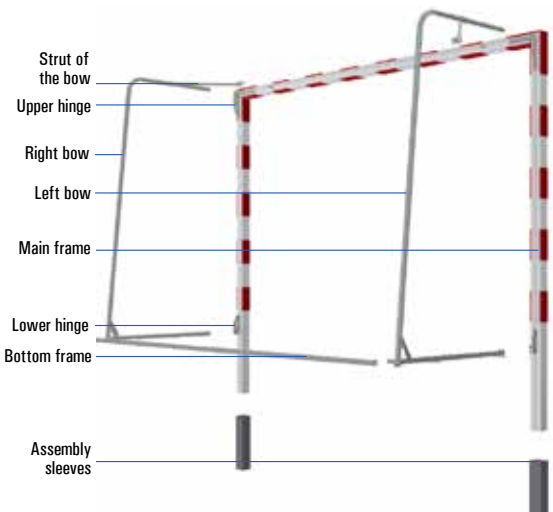

Aluminum



80x80 mm

Professional aluminum handball goals 2x3 m, made of reinforced aluminum profile 80x80 mm, with solid bows. Mounted in assembly sleeves. The main frame of the goal connected in the corners using special steel joints, with the possibility of dismantling.

3-43-1

The goals are available with the standard depth (bottom / top):

A - 1200 mm / 1000 mm

B - 1000 mm / 800 mm

PX - wall brackets in length $L = X$ [mm] (for wall-mounted goals)

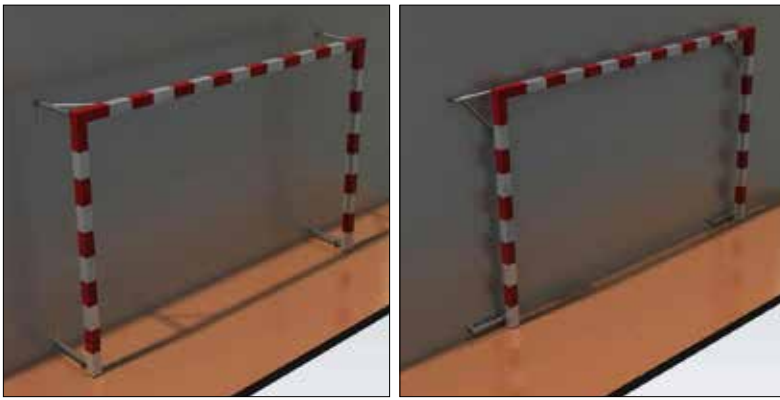

Wall-mounted handball goals 2x3 m, folded sideways

The frame made of steel or aluminum profile, mounted permanently to the wall, with the possibility of folding sideways, to increase the usable area of the hall. Steel elements, fixing the goal to the wall, hot dip galvanized. Bottom profiles equipped with plastic wheels, facilitating the folding of the goal; screwed upper struts stabilize the structure and block the goal in unfolded position.

3-31S



3-8-1000

Hook fixing the net to the goal on the washer



3-8-1001

Hook fixing the net to the goal on the screw



3-8-1005

Threaded cube for the hook on the screw



Hook fixing the net on the screw with threaded cube



3-51

Plastic handle fixing the net in aluminum profile

Handball nets

We offer a complete selection of nets for handball goals – with or without ball-catchers, made of polypropylene or polyethylene. Among the models are professional, training and tournament nets for outdoor or indoor use, and for beach handball.



Floorball | Goals



Floorball goals

Made of steel pipe, powder coated.

Available in four sizes. Training models equipped with a system of easy folding / unfolding, for easy transport and storage. The net is in the set.

Spring lock ensures stiffness of the bows after unfolding and prevents the automatic folding of the goal.



Model	Art. No.	Colour of the frame
Match floorball goal 115x160 cm	18-1	Red
Foldable club floorball goal 105x140 cm	18-2	Red and white
Foldable floorball goal for youth 60x90 cm	18-3	Red and white
Foldable mini floorball goal 45x60	18-4	Red and white

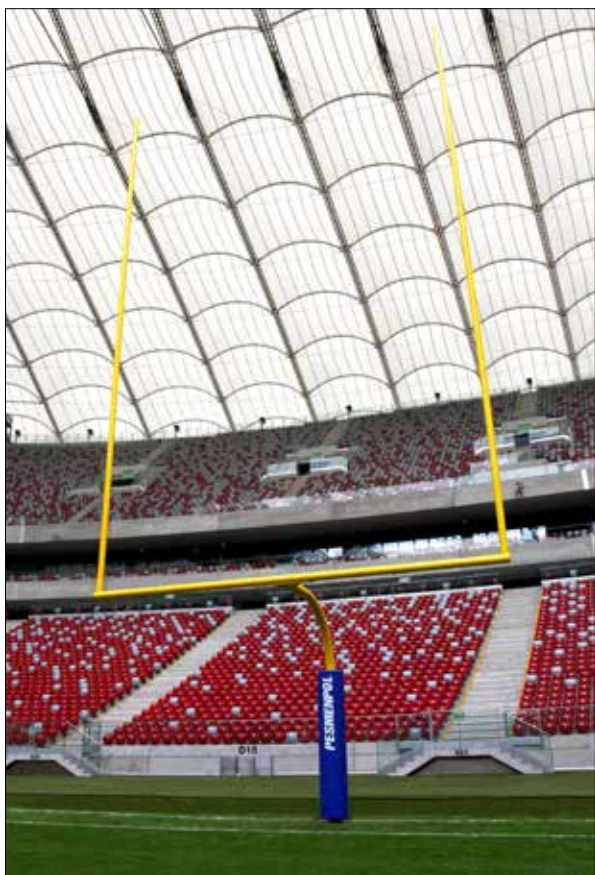

Professional steel American football goal



American football goals

Professional steel or steel and aluminum American football goals, installed in assembly sleeves. Equipped with safety pads. Powder coated in yellow. Compliant with NFL regulations.

An easy disassembly system of the goals improves their functionality on sports facilities of all types.

Professional steel American football goals, comply with NFL

Height 1215 cm, projection 172 cm, clear width 564 cm, crossbar height 305 cm; demountable. Equipped with protective pads 10 cm thick.

97-3

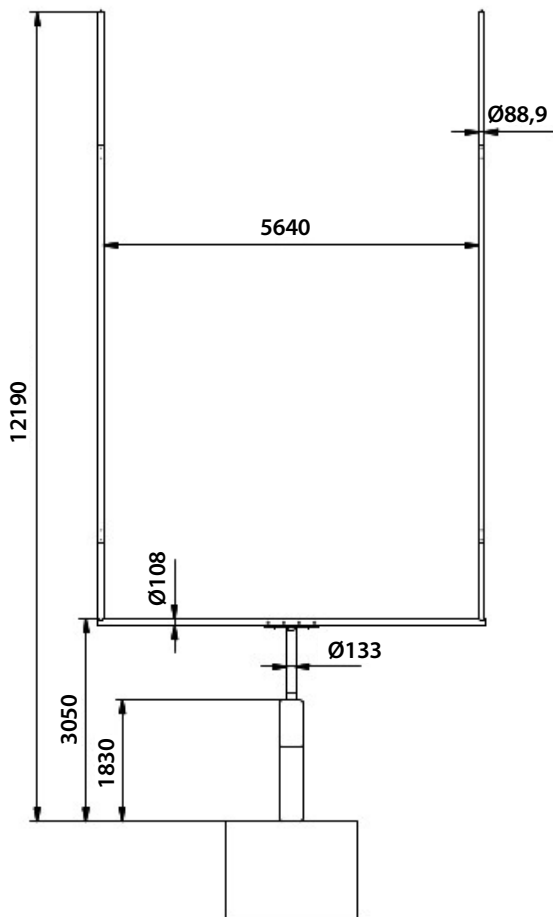

Protective pads for the post of American football goal, made of a sponge 10 cm thick, covered with synthetic leather on reinforcement structure, fastened with Velcro.



System of mounting the base, embedded in the ground, to the post

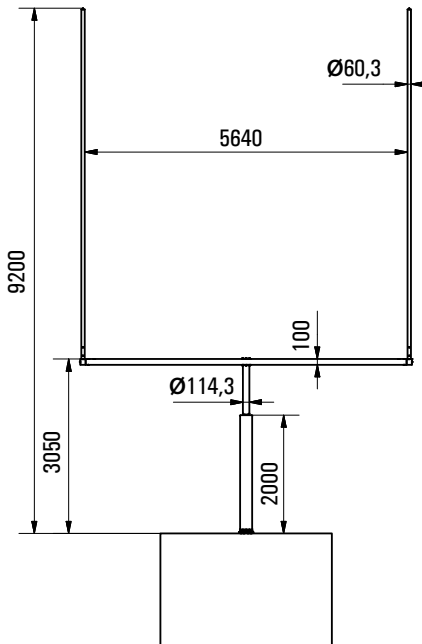
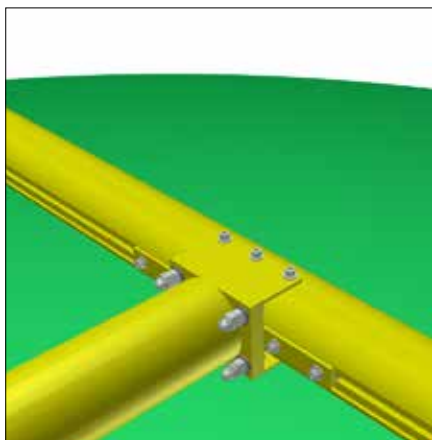
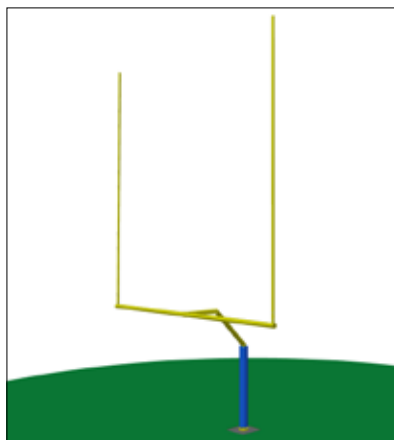

Professional steel and aluminum American football goals

Height 915 cm, projection 172 cm, clear width 564 cm, crossbar height 305 cm. Mounted in assembly sleeves. Equipped with protective pads.

97-2



Fixing the crossbar to the post

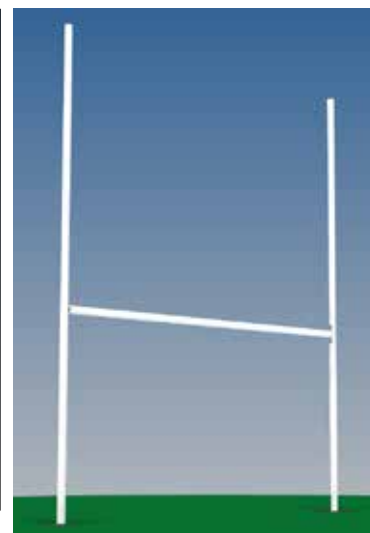

Rugby goals

The posts and the crossbar are made of special oval aluminum profile 120x100 mm. The components are connected by a permanent hot dip galvanized steel connector. The goals are made in accordance with International Rugby Board regulations.

Parameters:

- made of oval aluminum profile 120x100 mm;
- clear width: 560 cm;
- height from the ground: 700 cm;
- crossbar height 300 cm;
- colour: white;
- mounted in steel assembly sleeves, demountable;
- single-section vertical profiles.

Assembly sleeve for oval aluminum post

Assembly sleeve for oval posts of rugby goal, made of steel, intended for outdoor use.

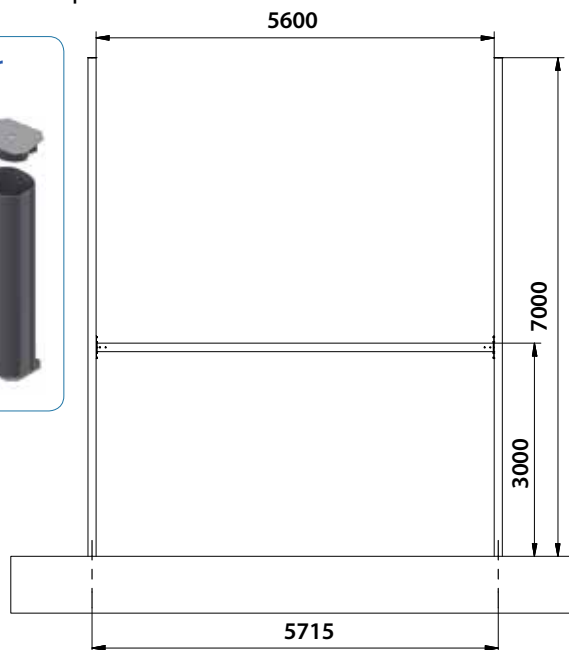

97-10